



## LE FLEUR DRYER CHAIR

SKU:2660-120



The Le Fleur Dryer Chair features premium quilted upholstery in an open flower stitched pattern and sleek, durable urethane arms. The Collins Sol-Air Dryer with exact temperature controls is also included.

The Le Fleur chair is a beautiful classic piece that shows your clients that you have an eye for detail.

### TECHNICAL INFORMATION

---

- Width between the arms 22.50"
- Width outside the arms 26"
- Height to the top of the hood bent down 48"-57"
- Height to top of seat 18"
- Depth of seat 18.5"
- Overall depth 32"

### SHIPPING INFORMATION

---

Item generally ships via Freight(Truck) service

- Weight: 84 lbs
- Dimensions: 2 cartons measuring 17"x15"x34" and 33"x25"x36"

### WARRANTY

---

#### 5 YEARS:

- Sol Air dryer motors & hoods

#### 3 YEARS:

- Molded urethane arms
- Upholstery

#### 2 YEARS:

- Jeffco K500 and Collins 2200 dryers

#### 1 YEAR:

- All remaining components, unless noted otherwise



### Additional Information

Assembly required - yes  
 Electrical required - no  
 Plumbing required - yes  
 Wall blocking required - yes  
 COM yardage/laminate usage - 178 sf  
 4" h laminated plywood toe + 1/4" h glides  
 Other (specify) - n/a  
 Other (specify) - n/a

### Specification Drawing

This **Specification Drawing** is intended for communicating the basic description, function, appearance, dimensions, features, and installation of an item as manufactured by Collins Manufacturing Company. Because this drawing does not contain project specific information such as quantities, finishes, or options, it is not an approval drawing and does not require a signature. This drawing remains the property of Collins Manufacturing Company and must not be used against the interests of Collins Manufacturing Company.

### Product Information

		Collins Manufacturing 2000 Bowser Road Cookeville, TN 38506	
Name: 10 Foot Organizer			
Size: NTS	Part Number: 2660-120	Drawn By: Eng	
Prepared Date: 5/29/20	Revision Date: Date	Revision Number: Rev #	Sheet: 1 of 4

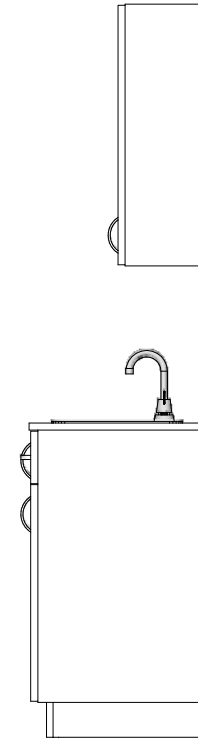
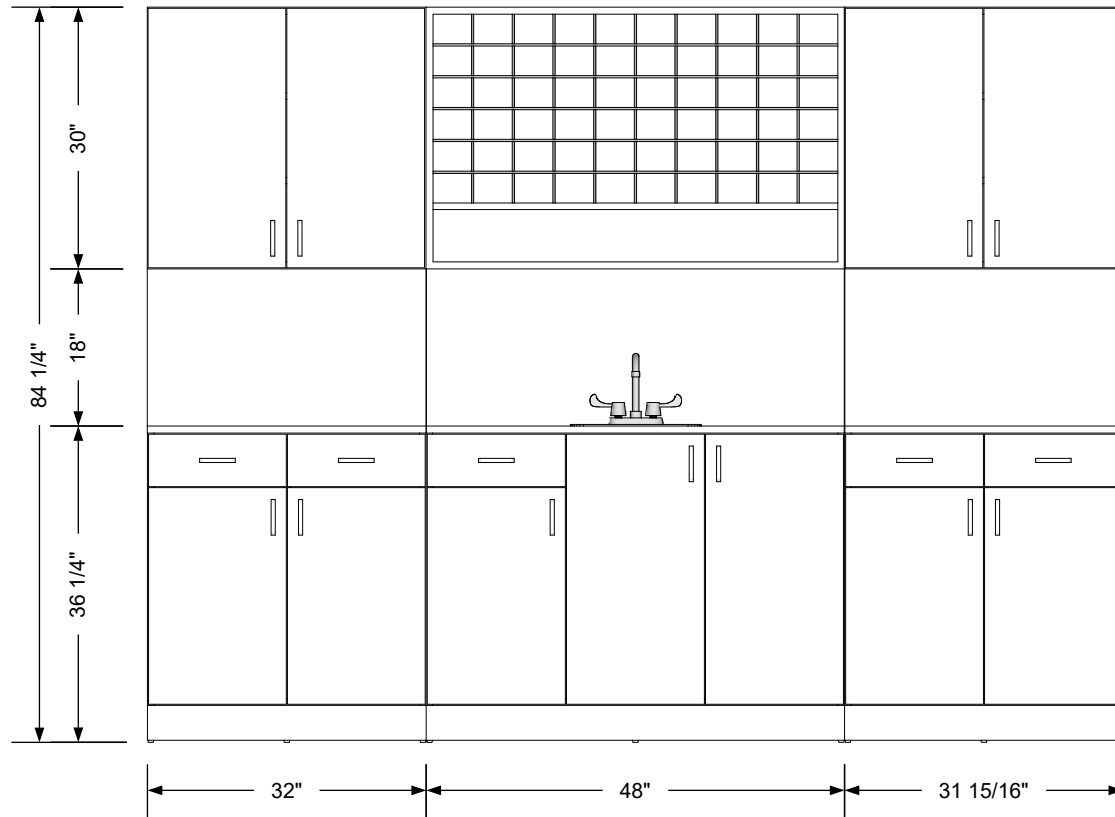
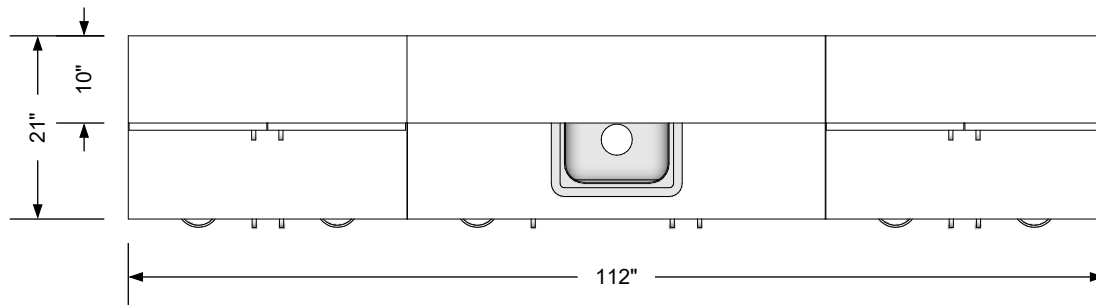

### Additional Information

Assembly required - yes  
 Electrical required - no  
 Plumbing required - yes  
 Wall blocking required - yes  
 COM yardage/laminate usage - 178 sf  
 4" h laminated plywood toe + 1/4" h glides  
 Other (specify) - n/a  
 Other (specify) - n/a

### Specification Drawing

This **Specification Drawing** is intended for communicating the basic description, function, appearance, dimensions, features, and installation of an item as manufactured by Collins Manufacturing Company. Because this drawing does not contain project specific information such as quantities, finishes, or options, it is not an approval drawing and does not require a signature. This drawing remains the property of Collins Manufacturing Company and must not be used against the interests of Collins Manufacturing Company.

### Product Information

		Collins Manufacturing 2000 Bowser Road Cookeville, TN 38506	
Name: 10 Foot Organizer			
Size: NTS	Part Number: 2660-120	Drawn By: Eng	
Prepared Date: 5/29/20	Revision Date: Date	Revision Number: Rev #	Sheet: 2 of 4

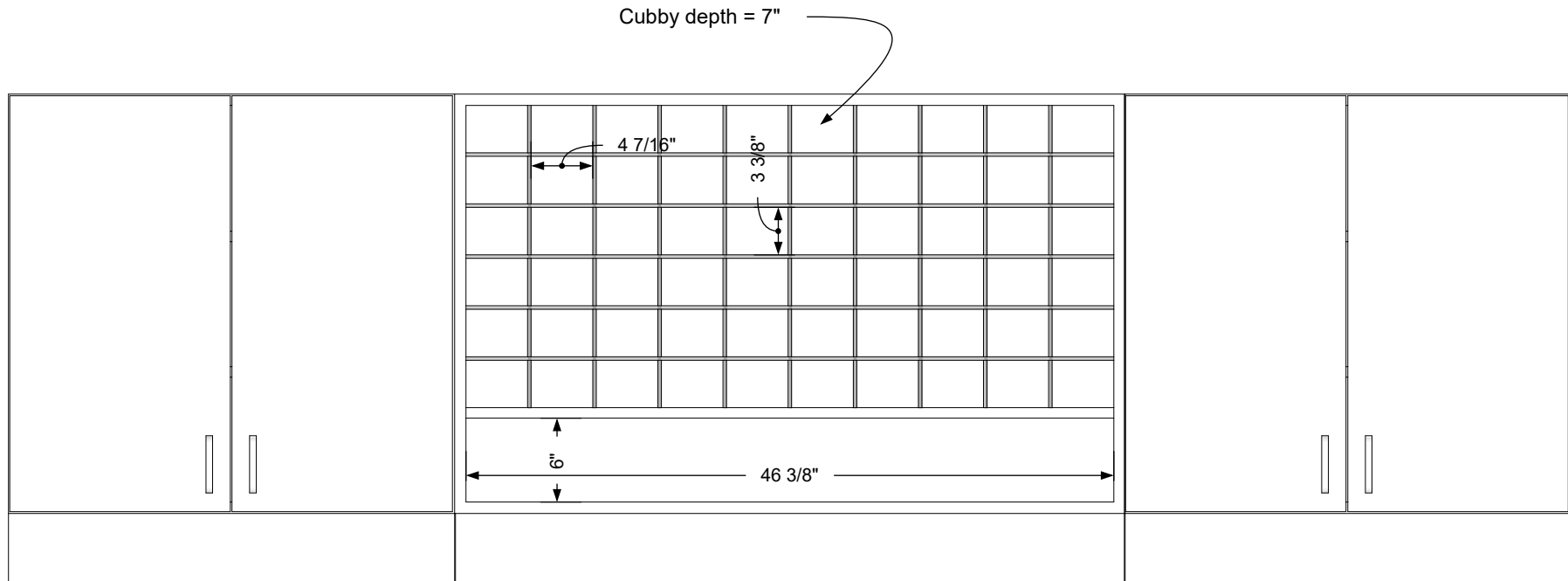

**Cubby details**

**Additional Information**

Assembly required - yes  
 Electrical required - no  
 Plumbing required - yes  
 Wall blocking required - yes  
 COM yardage/laminate usage - 178 sf  
 4" h laminated plywood toe + 1/4" h glides  
 Other (specify) - n/a  
 Other (specify) - n/a

**Specification Drawing**

This **Specification Drawing** is intended for communicating the basic description, function, appearance, dimensions, features, and installation of an item as manufactured by Collins Manufacturing Company. Because this drawing does not contain project specific information such as quantities, finishes, or options, it is not an approval drawing and does not require a signature. This drawing remains the property of Collins Manufacturing Company and must not be used against the interests of Collins Manufacturing Company.

**Product Information**

		Collins Manufacturing 2000 Bowser Road Cookeville, TN 38506	
Name: 10 Foot Organizer			
Size: NTS	Part Number: 2660-120	Drawn By: Eng	
Prepared Date: 5/29/20	Revision Date: Date	Revision Number: Rev #	Sheet: 3 of 4

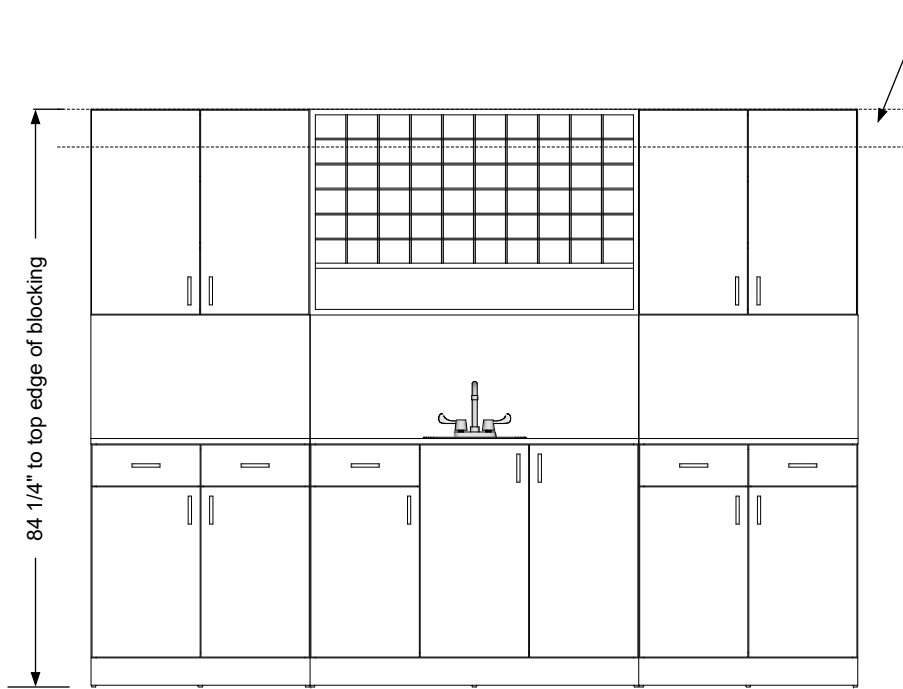

**Blocking detail**

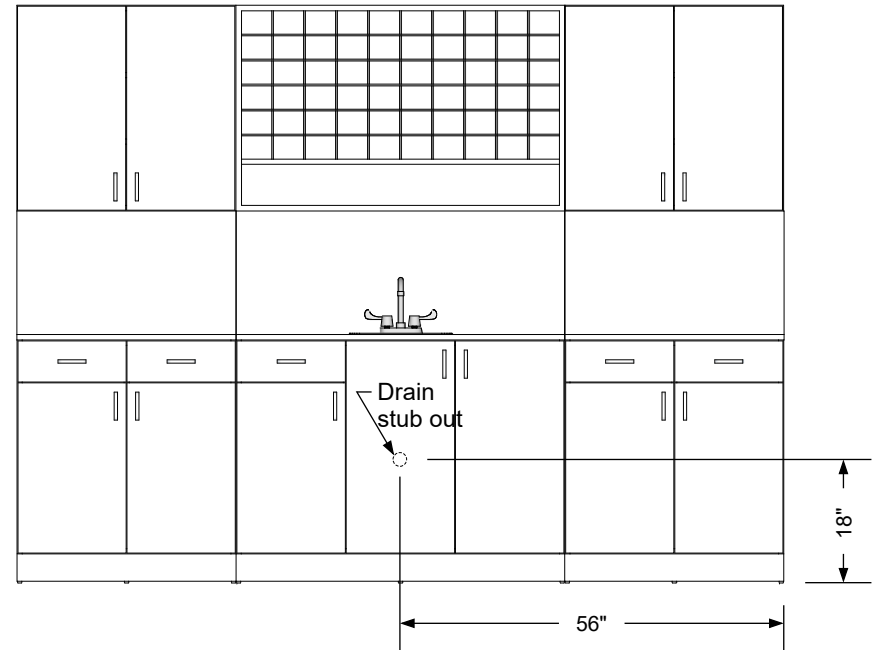

**Plumbing stub out detail**

**Additional Information**

Assembly required - yes  
 Electrical required - no  
 Plumbing required - yes  
 Wall blocking required - yes  
 COM yardage/laminate usage - 178 sf  
 4"h laminated plywood toe + 1/4"h glides  
 Other (specify) - n/a  
 Other (specify) - n/a

**Specification Drawing**

This **Specification Drawing** is intended for communicating the basic description, function, appearance, dimensions, features, and installation of an item as manufactured by Collins Manufacturing Company. Because this drawing does not contain project specific information such as quantities, finishes, or options, it is not an approval drawing and does not require a signature. This drawing remains the property of Collins Manufacturing Company and must not be used against the interests of Collins Manufacturing Company.

**Product Information**

		Collins Manufacturing 2000 Bowser Road Cookeville, TN 38506	
Name: 10 Foot Organizer			
Size: NTS	Part Number: 2660-120	Drawn By: Eng	
Prepared Date: 5/29/20	Revision Date: Date	Revision Number: Rev #	Sheet: 4 of 4