



BRADFORD WET STATION

SKU:879-54



With the Bradford Wet Station you can design the perfect space. Create a classic and stylish accent in your salon with crown molding details that enrich the space by forming an eye-catching transition between the walls and ceiling. The Queen Anne legs detail make this a timeless piece that will not go out of style. This traditional style can fit into any decor with just the change of the laminate color.

Wet booths allow the guest to conveniently stay in the same seat for shampooing and styling. They are perfect for small spaces, barber shops or elderly care salons.

TECHNICAL INFORMATION

- Measures: 52"W x 15"D x 75"H
- Lift-lid
- Concealed bottle wells
- Drawer
- Tip-out tool panel right of bowl
- Soiled-Towel bin
- Upper cabinets w/ adjustable shelves
- Queen Anne legs
- Crown molding
- Mirror
- Light wired by salon
- Bowl ordered separately

SHIPPING INFORMATION

Item generally ships via Freight(Truck) service

- Weight: 443 lbs
- Dimensions: 2 SKIDS

WARRANTY

3 Years:

- Ball-Bearing Drawer Slides
- Cabinet hinges

1 Year:

- All remaining components, unless noted otherwise, are guaranteed for a period of one year from the date of purchase.

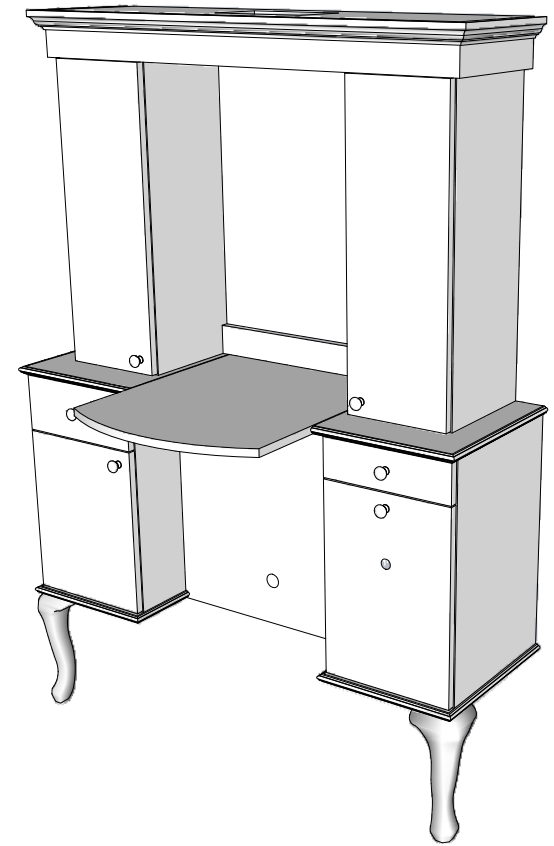
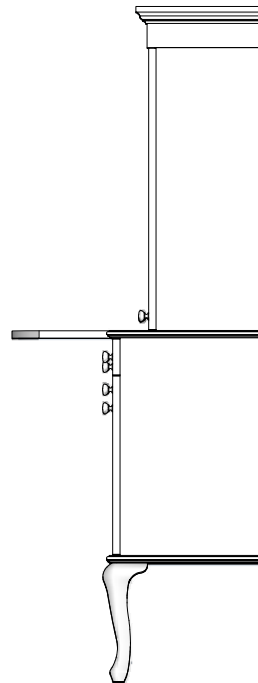
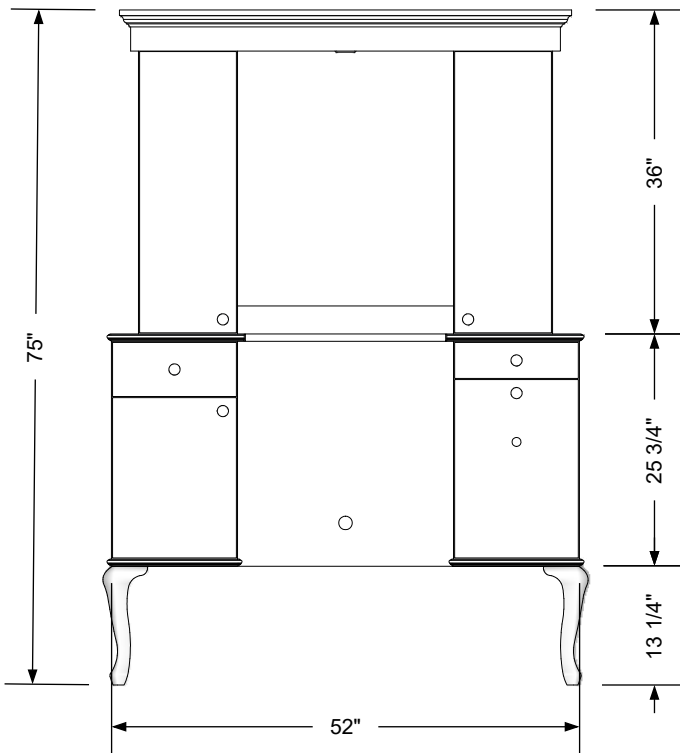
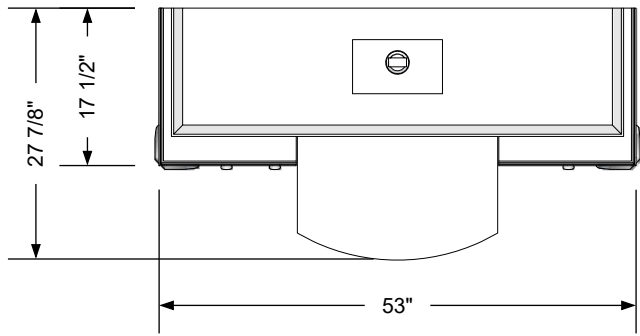

Additional Information

Assembly required - yes
 Electrical required - yes
 Plumbing required - yes
 Wall blocking required - yes
 COM yardage/laminate usage - 74 sf
 13 1/4"h Queen Anne legs
 Other (specify) - n/a
 Other (specify) - n/a

Specification Drawing

This **Specification Drawing** is intended for communicating the basic description, function, appearance, dimensions, features, and installation of an item as manufactured by Collins Manufacturing Company. Because this drawing does not contain project specific information such as quantities, finishes, or options, it is not an approval drawing and does not require a signature. This drawing remains the property of Collins Manufacturing Company and must not be used against the interests of Collins Manufacturing Company.

Product Information

		Collins Manufacturing 2000 Bowser Road Cookeville, TN 38506	
Name: Bradford B Wet Booth Unit			
Size: NTS	Part Number: 879-54	Drawn By: Eng	
Prepared Date: 3/19/21	Revision Date: Date	Revision Number: Rev #	Sheet: 1 of 3

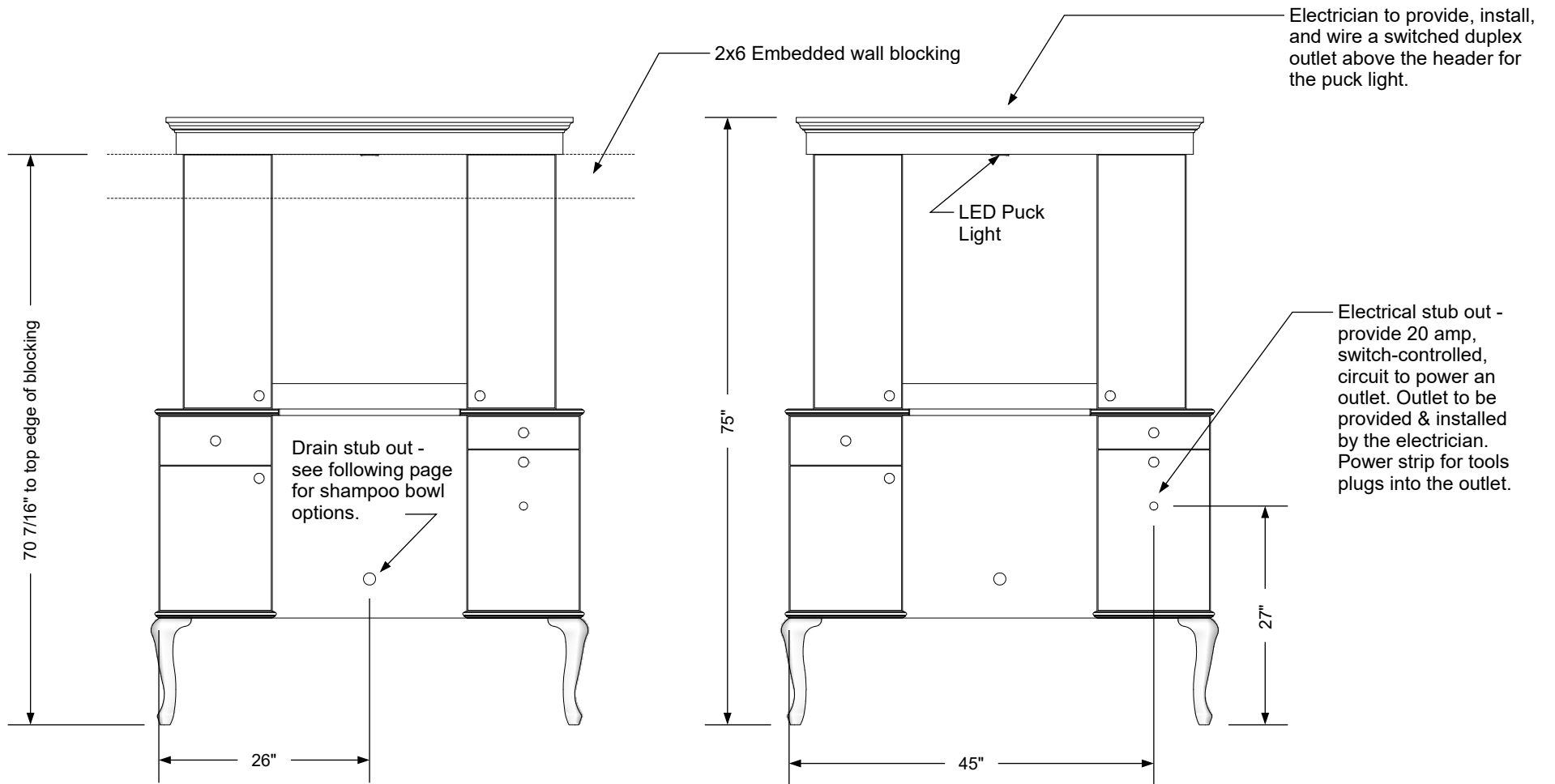

Plumbing stub & blocking detail

Electrical stub out detail

Additional Information

Assembly required - yes
 Electrical required - yes
 Plumbing required - yes
 Wall blocking required - yes
 COM yardage/laminate usage - 74 sf
 13 1/4"h Queen Anne legs
 Other (specify) - n/a
 Other (specify) - n/a

Specification Drawing

This **Specification Drawing** is intended for communicating the basic description, function, appearance, dimensions, features, and installation of an item as manufactured by Collins Manufacturing Company. Because this drawing does not contain project specific information such as quantities, finishes, or options, it is not an approval drawing and does not require a signature. This drawing remains the property of Collins Manufacturing Company and must not be used against the interests of Collins Manufacturing Company.

Product Information

		Collins Manufacturing 2000 Bowser Road Cookeville, TN 38506	
Name: Bradford B Wet Booth Unit			
Size: NTS	Part Number: 879-54	Drawn By: Eng	
Prepared Date: 3/19/21	Revision Date: Date	Revision Number: Rev #	Sheet: 2 of 3

Not Recommended With The 879-54 Due To The Height Of The Queen Anne Legs

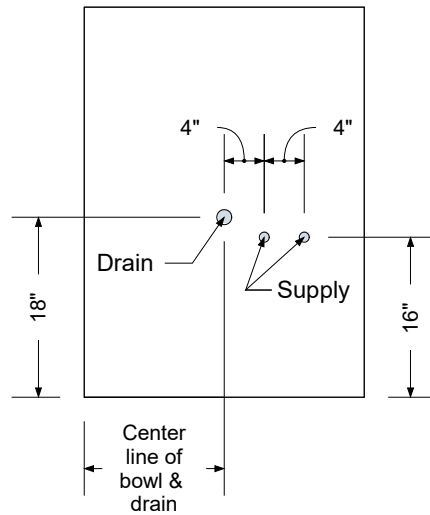

Standard Shampoo Bowl

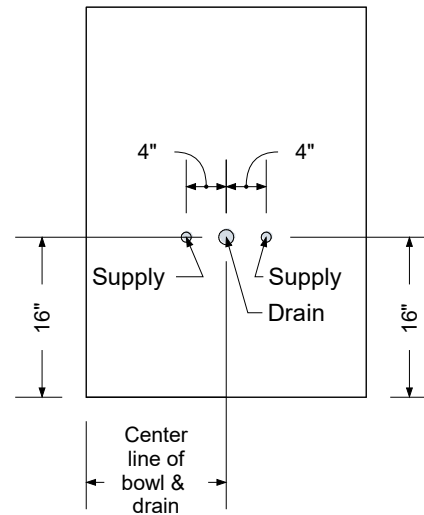

T100 w/ Tilting Shampoo Bowl
Note: Lift Lid Must Be Reduced In Size To Use This Option.

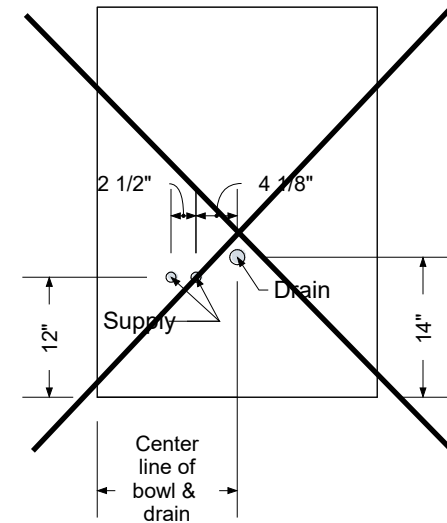

K100 Adjust-A-Sink Shampoo Bowl
Note: Lift Lid Must Be Reduced In Size To Use This Option.

Typical Collins Shampoo Bowl Options

Additional Information

Assembly required - yes
 Electrical required - yes
 Plumbing required - yes
 Wall blocking required - yes
 COM yardage/laminate usage - 74 sf
 13 1/4"h Queen Anne legs
 Other (specify) - n/a
 Other (specify) - n/a

Specification Drawing

This **Specification Drawing** is intended for communicating the basic description, function, appearance, dimensions, features, and installation of an item as manufactured by Collins Manufacturing Company. Because this drawing does not contain project specific information such as quantities, finishes, or options, it is not an approval drawing and does not require a signature. This drawing remains the property of Collins Manufacturing Company and must not be used against the interests of Collins Manufacturing Company.

Product Information

		Collins Manufacturing 2000 Bowser Road Cookeville, TN 38506	
Name: Bradford B Wet Booth Unit			
Size: NTS	Part Number: 879-54	Drawn By: Eng	
Prepared Date: 3/19/21	Revision Date: Date	Revision Number: Rev #	Sheet: 3 of 3