



## HEX ISLAND

SKU:2144-72

Hexagon Six-Student School Station, reference 32991.3.  
Inquire with your distributor or the factory for pricing on school quantities.

### TECHNICAL INFORMATION

- 72"W x 72"D x 72"H
- Each section features:
- Open storage below counter
  - Tool holders mounted in round counter top
  - Quad outlet mounted in splash just below each of the six mirrors

### SHIPPING INFORMATION

Item generally ships via Freight(Truck) service

- Weight: 740 lbs
- Dimensions: 3 pallets

### WARRANTY

#### 3 Years:

- Ball-Bearing Drawer Slides
- Cabinet hinges

#### 1 Year:

- All remaining components, unless noted otherwise, are guaranteed for a period of one year from the date of purchase.



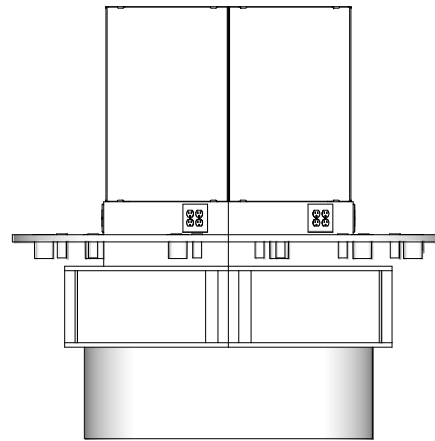
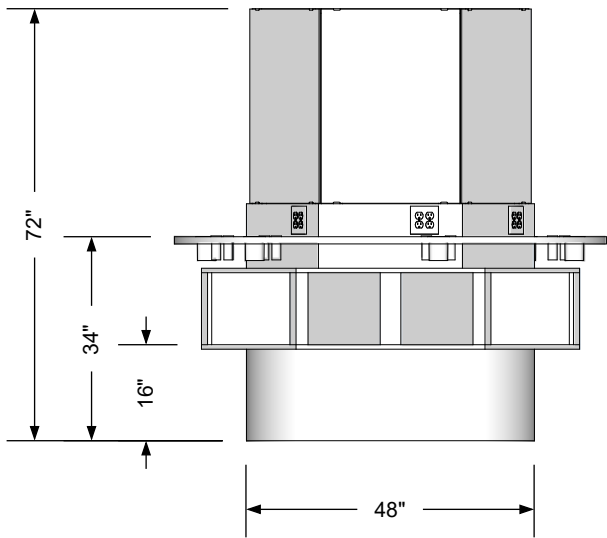
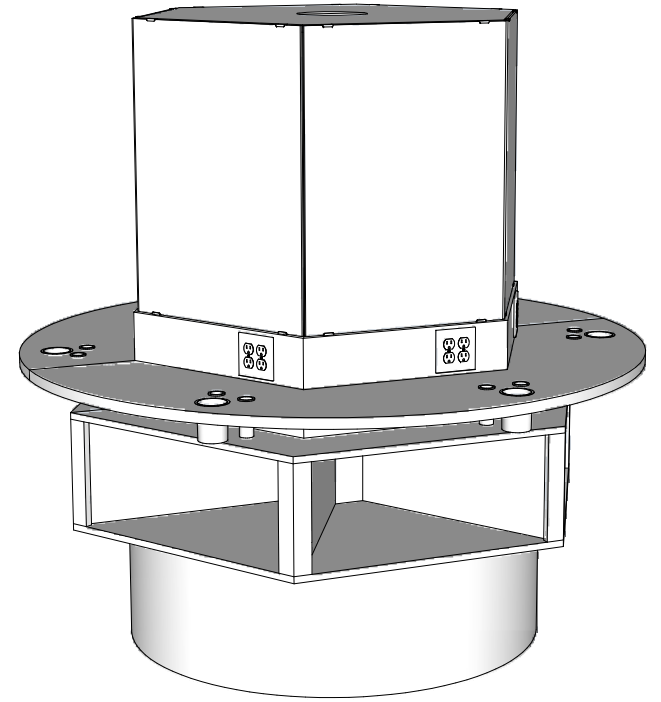
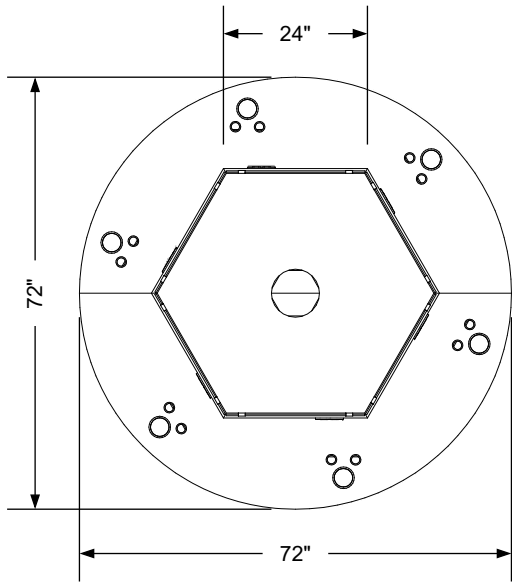

### Additional Information

Assembly required - yes  
 Electrical required - yes  
 Plumbing required - no  
 Wall blocking required - no  
 COM yardage/laminate usage - 266 sf  
 4" h laminated plywood toe + 1/4" h glides  
 Other (specify) - n/a  
 Other (specify) - n/a

### Specification Drawing

This **Specification Drawing** is intended for communicating the basic description, function, appearance, dimensions, features, and installation of an item as manufactured by Collins Manufacturing Company. Because this drawing does not contain project specific information such as quantities, finishes, or options, it is not an approval drawing and does not require a signature. This drawing remains the property of Collins Manufacturing Company and must not be used against the interests of Collins Manufacturing Company.

### Product Information

|   |                                |   |                         |
|---|--------------------------------|---|-------------------------|
|  |                                | Collins Manufacturing<br>2000 Bowser Road<br>Cookeville, TN 38506 |                         |
| Name: <b>Hex Station</b>  |                                |   |                         |
| Size:<br><b>NTS</b>   | Part Number:<br><b>2144-72</b> | Drawn By:<br><b>Eng</b>   |                         |
| Prepared Date:<br><b>5/8/20</b>   | Revision Date:<br><b>Date</b>  | Revision Number:<br><b>Rev #</b>                                  | Sheet:<br><b>1 of 2</b> |

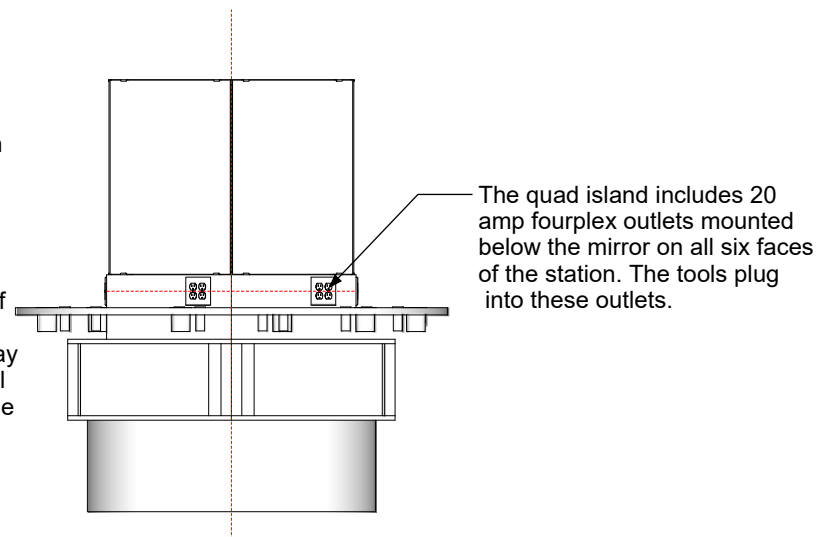
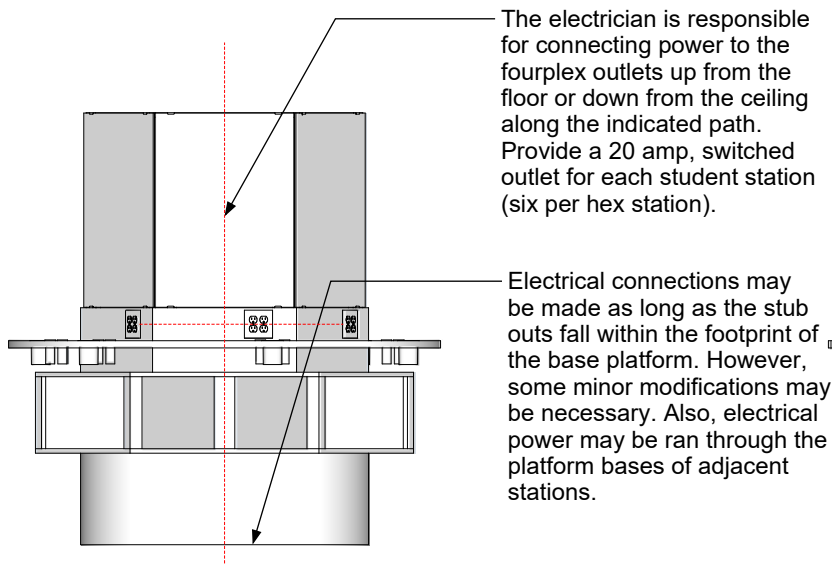
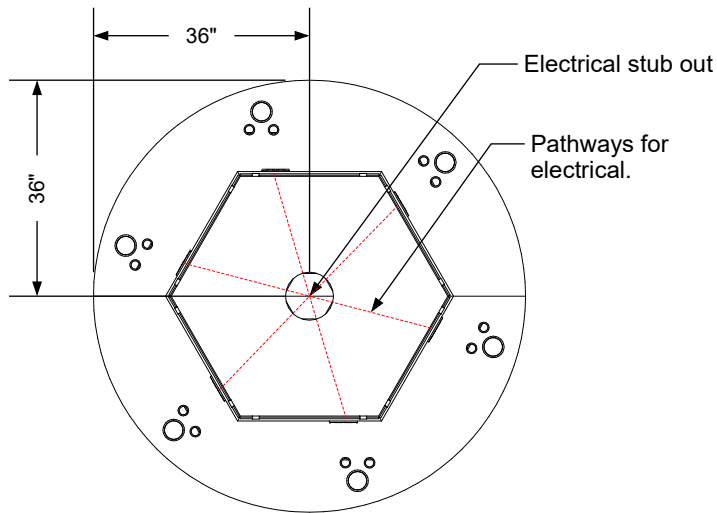

### Electrical stub out detail

#### Additional Information

Assembly required - yes  
 Electrical required - yes  
 Plumbing required - no  
 Wall blocking required - no  
 COM yardage/laminate usage - 266 sf  
 4"h laminated plywood toe + 1/4"h glides  
 Other (specify) - n/a  
 Other (specify) - n/a

#### Specification Drawing

This **Specification Drawing** is intended for communicating the basic description, function, appearance, dimensions, features, and installation of an item as manufactured by Collins Manufacturing Company. Because this drawing does not contain project specific information such as quantities, finishes, or options, it is not an approval drawing and does not require a signature. This drawing remains the property of Collins Manufacturing Company and must not be used against the interests of Collins Manufacturing Company.

#### Product Information

|                                 |                                |   |                         |
|---------------------------------|--------------------------------|---|-------------------------|
|                                 |                                | Collins Manufacturing<br>2000 Bowser Road<br>Cookeville, TN 38506 |                         |
| Name: <b>Hex Station</b>        |                                |   |                         |
| Size:<br><b>NTS</b>             | Part Number:<br><b>2144-72</b> | Drawn By:<br><b>Eng</b>   |                         |
| Prepared Date:<br><b>5/8/20</b> | Revision Date:<br><b>Date</b>  | Revision Number:<br><b>Rev #</b>                                  | Sheet:<br><b>2 of 2</b> |