



DUCTED MANICURE TABLE

SKU:2265-48

Vented - Ducted Manicure Table w/ drawers. This manicure table works perfectly in states that require ventilation to the outside by hooking directly up to your HVAC installed exterior duct and fan system.

TECHNICAL INFORMATION

- 48"W x 20"D x 32"H
- Featuring built-in plenum to hook to wall mounted ventilation system (not included)
- Three drawers
- Stainless vent cover
- Slim line LED light
- Padded rest, not pictured

SHIPPING INFORMATION

Item generally ships via Freight(Truck) service

- Weight: 210 lbs
- Dimensions: 54"L x 32"W x 42"H

WARRANTY

3 Years:

- Ball-Bearing Drawer Slides
- Cabinet hinges

1 Year:

- All remaining components, unless noted otherwise, are guaranteed for a period of one year from the date of purchase.



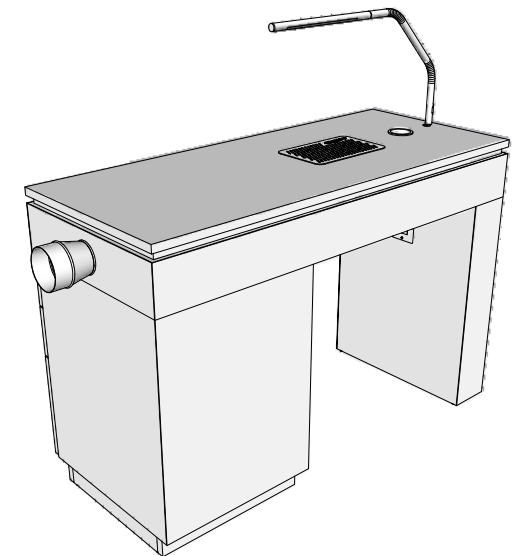
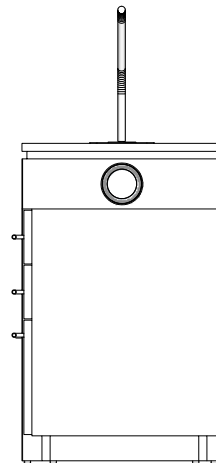
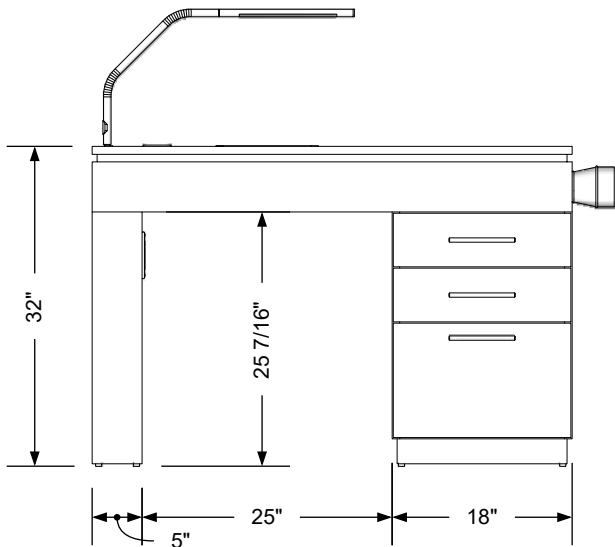
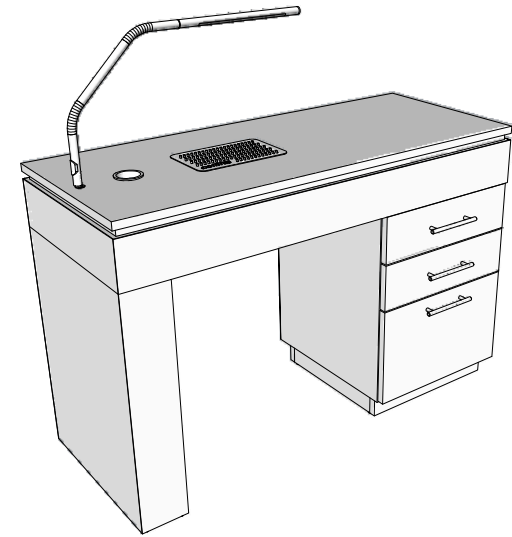
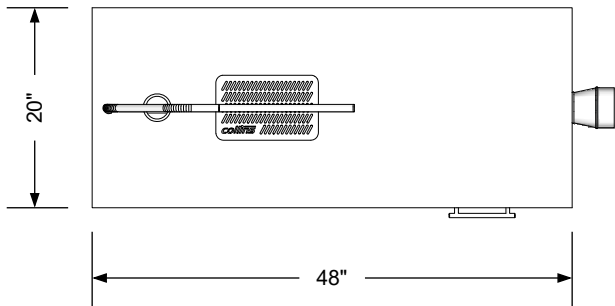

Additional Information

Assembly required - yes
 Electrical required - yes
 Plumbing required - no
 Wall blocking required - no
 COM yardage/laminate usage - 64 sf
 2 1/2" h laminated plywood toe + 1/4" h glides
 Ventilation required - yes
 Other (specify) - n/a

Specification Drawing

This **Specification Drawing** is intended for communicating the basic description, function, appearance, dimensions, features, and installation of an item as manufactured by Collins Manufacturing Company. Because this drawing does not contain project specific information such as quantities, finishes, or options, it is not an approval drawing and does not require a signature. This drawing remains the property of Collins Manufacturing Company and must not be used against the interests of Collins Manufacturing Company.

Product Information

		Collins Manufacturing 2000 Bowser Road Cookeville, TN 38506	
		Name: Ducted Manicure Table	
Size: NTS	Part Number: 2265-48	Drawn By: Eng	
Prepared Date: 5/20/20	Revision Date: 7/20/20	Revision Number: Rev #1	Sheet: 1 of 2

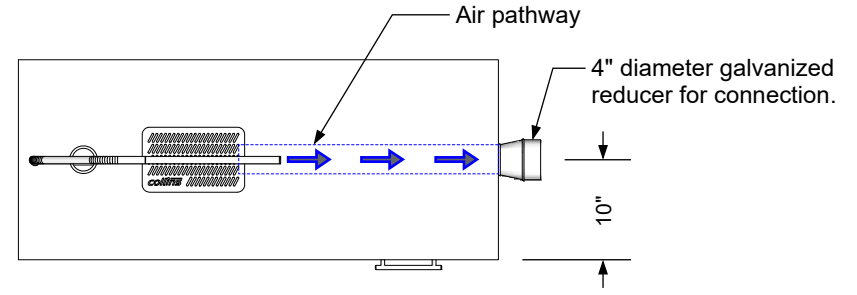
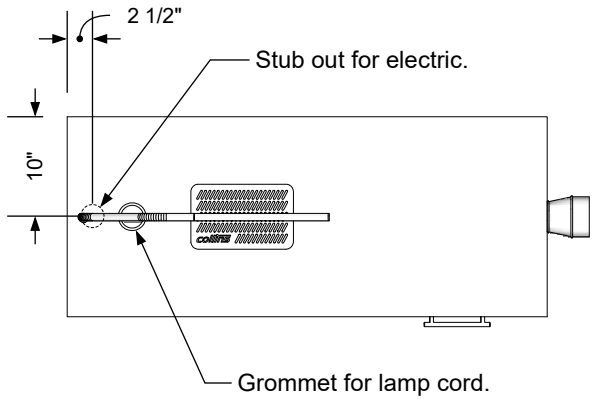

All connections from the nail table to the ventilation system to be provided and installed by others. All air movement calculations and air handling systems to be provided by HVAC contractor.

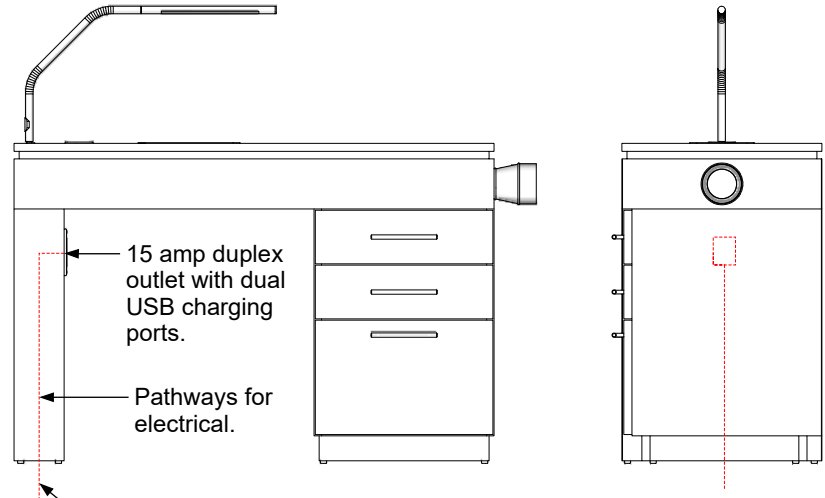

The electrician is responsible for connecting power to the outlet from the floor. Provide a 15 amp, switched circuit for each nail table.

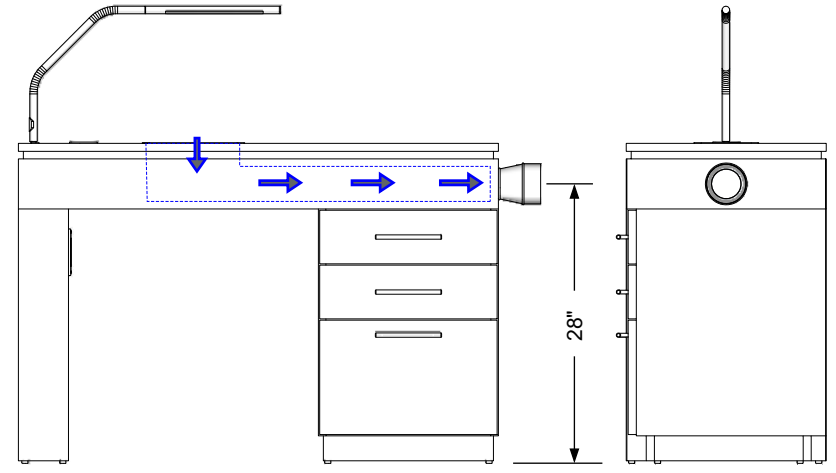

Ventilation detail

Electrical stub out detail

Additional Information

Assembly required - yes
 Electrical required - yes
 Plumbing required - no
 Wall blocking required - no
 COM yardage/laminate usage - 64 sf
 2 1/2"h laminated plywood toe + 1/4"h glides
 Ventilation required - yes
 Other (specify) - n/a

Specification Drawing

This **Specification Drawing** is intended for communicating the basic description, function, appearance, dimensions, features, and installation of an item as manufactured by Collins Manufacturing Company. Because this drawing does not contain project specific information such as quantities, finishes, or options, it is not an approval drawing and does not require a signature. This drawing remains the property of Collins Manufacturing Company and must not be used against the interests of Collins Manufacturing Company.

Product Information

		Collins Manufacturing 2000 Bowser Road Cookeville, TN 38506	
Name: Ducted Manicure Table			
Size: NTS	Part Number: 2265-48	Drawn By: Eng	
Prepared Date: 5/20/20	Revision Date: 7/20/20	Revision Number: Rev #1	Sheet: 2 of 2