



LEHIGH++ SINGLE

SKU:2164-48

For one student...featuring tool holders, mannequin head clamp strip and mannequin head storage cubbie, fourplex outlet, student kit storage, PLUS pull out work and writing ledge, and mirror

TECHNICAL INFORMATION

- 48"W x 22"D x 87"H
- Tool holders
- Mannequin head clamp strip
- Mannequin head storage cubby
- Fourplex outlet
- Student kit storage
- Pull out work and writing ledge
- Mirror

SHIPPING INFORMATION

Item generally ships via Freight(Truck) service

- Weight: 290 lbs
- Dimensions: 2 pallets

WARRANTY

3 Years:

- Ball-Bearing Drawer Slides
- Cabinet hinges

1 Year:

- All remaining components, unless noted otherwise, are guaranteed for a period of one year from the date of purchase.



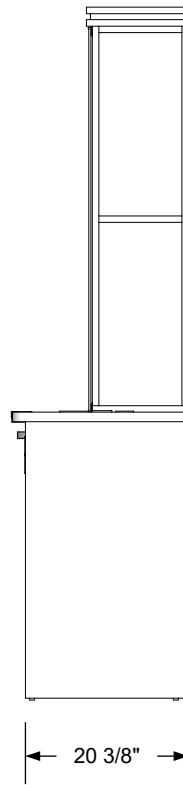
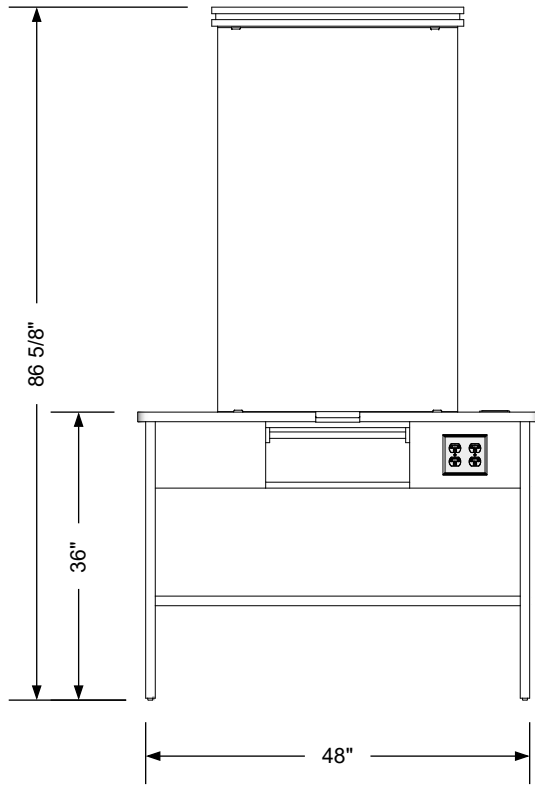
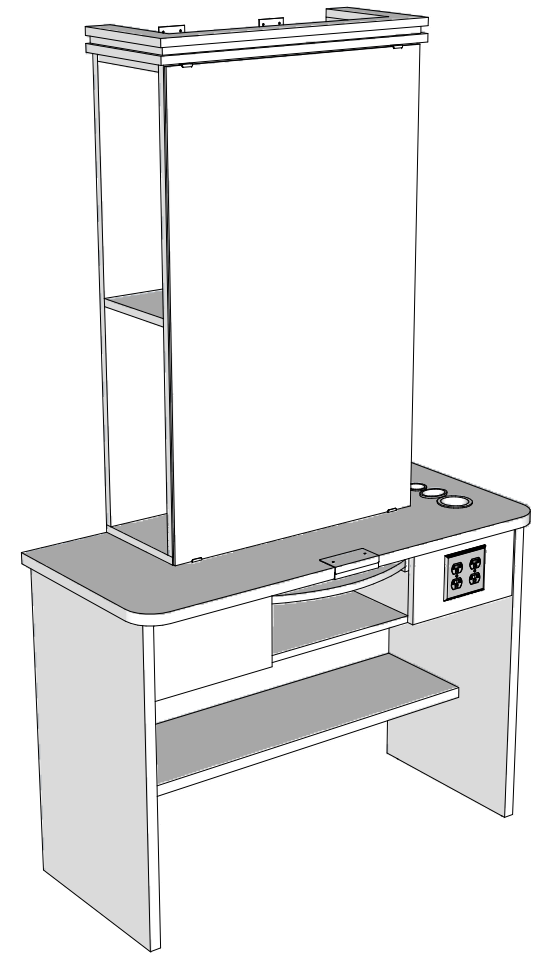
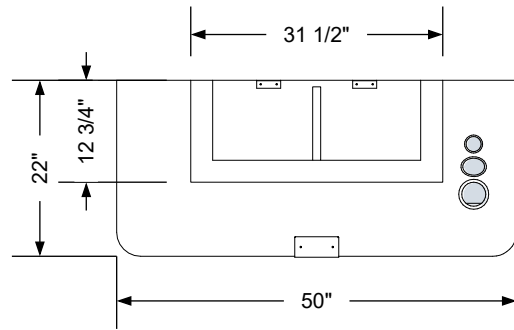

Additional Information

Assembly required - yes
 Electrical required - yes
 Plumbing required - no
 Wall blocking required - yes
 COM yardage/laminate usage - 88 sf
 Laminated support legs + 1/4" h glides
 Other (specify) - n/a
 Other (specify) - n/a

Specification Drawing

This **Specification Drawing** is intended for communicating the basic description, function, appearance, dimensions, features, and installation of an item as manufactured by Collins Manufacturing Company. Because this drawing does not contain project specific information such as quantities, finishes, or options, it is not an approval drawing and does not require a signature. This drawing remains the property of Collins Manufacturing Company and must not be used against the interests of Collins Manufacturing Company.

Product Information

		Collins Manufacturing 2000 Bowser Road Cookeville, TN 38506	
Name: Lehigh Plus Plus Single			
Size: NTS	Part Number: 2164-48	Drawn By: Eng	
Prepared Date: 5/5/20	Revision Date: Date	Revision Number: Rev #	Sheet: 1 of 2

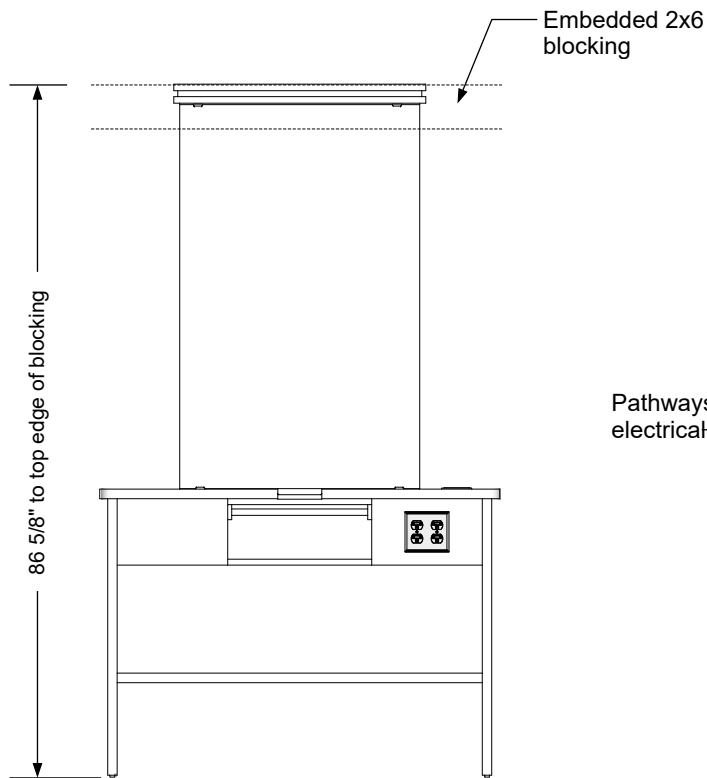
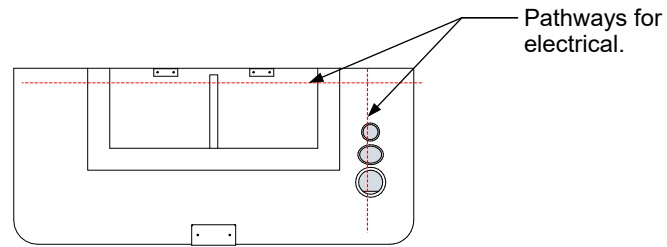

Wall blocking detail

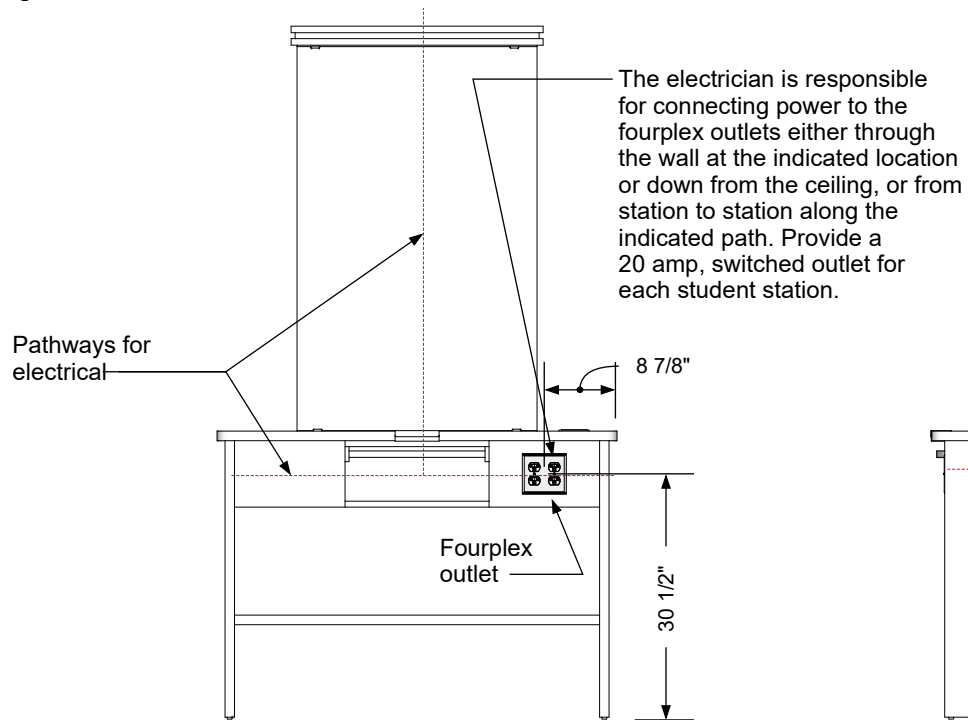

Electrical stub out detail

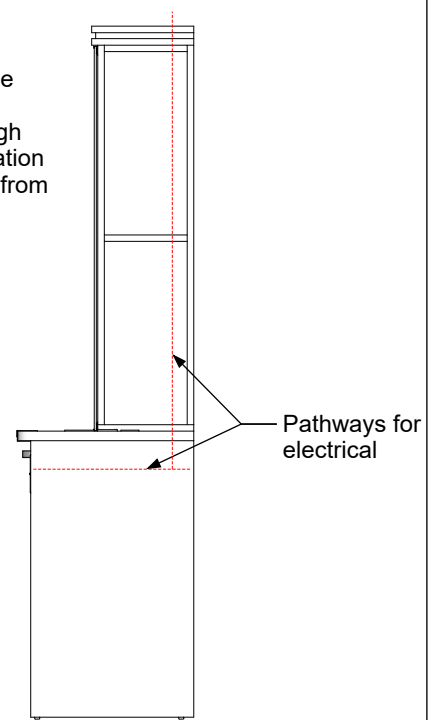

Additional Information

Assembly required - yes
 Electrical required - yes
 Plumbing required - no
 Wall blocking required - yes
 COM yardage/laminate usage - 88 sf
 Laminated support legs + 1/4" h glides
 Other (specify) - n/a
 Other (specify) - n/a

Specification Drawing

This **Specification Drawing** is intended for communicating the basic description, function, appearance, dimensions, features, and installation of an item as manufactured by Collins Manufacturing Company. Because this drawing does not contain project specific information such as quantities, finishes, or options, it is not an approval drawing and does not require a signature. This drawing remains the property of Collins Manufacturing Company and must not be used against the interests of Collins Manufacturing Company.

Product Information

		Collins Manufacturing 2000 Bowser Road Cookeville, TN 38506	
Name: Lehigh Plus Plus Single			
Size: NTS	Part Number: 2164-48	Drawn By: Eng	
Prepared Date: 5/5/20	Revision Date: Date	Revision Number: Rev #	Sheet: 2 of 2